

STRUCTURAL NOTES:

- THIS NON-POROUS SYSTEM HAS BEEN VERIFIED FOR COMPLIANCE IN ACCORDANCE WITH THE 2014 (FIFTH EDITION) OF THE FLORIDA BUILDING CODE (FBC) FOR USE WITHIN THE HIGH VELOCITY HURRICANE ZONE (MIAMI-DADE/ BROWARD COUNTIES). IT MAY BE INSTALLED IN WIND ZONE 4 AND/OR ESSENTIAL FACILITIES IN WIND ZONES 1,2,3 OR 4 WITH STORM BARS AS NOTED ON SHEET 2 OF 10. THE ADEQUACY FOR IMPACT, DEFLECTION AND FATIGUE RESISTANCE HAS BEEN VERIFIED IN ACCORDANCE WITH SECTION 1626 (HVHZ) OF THE ABOVE REFERENCED CODE, AND AS PER TAS 201, TAS 202 AND TAS 203 AS LISTED HEREIN AS WELL AS ADDITIONAL STANDARDS AS MENTIONED ELSEWHERE ON SHEET 1 OF 10.
- DESIGN PRESSURE REQUIREMENTS OF A SPECIFIC SITE SHALL BE DETERMINED BY OTHERS IN CONFORMANCE TO SECTION 1609 OF THE FBC FOR A BASIC WIND SPEED (ALLOWABLE STRESS DESIGN) AS REQUIRED BY THE JURISDICTION WHERE THE SYSTEM WILL BE INSTALLED. ULTIMATE DESIGN LOADS (UDL) DETERMINED BY ASCE 7-10 SHALL BE REDUCED TO ALLOWABLE STRESS DESIGN LOADS (ASD) BY MULTIPLYING THE UDL BY 0.6 TO COMPARE THEM TO THE ASD PRESSURE RATINGS SHOWN ON SHEET 2. USE OF DIRECTIONALITY FACTOR Kd=0.85 IS ALLOWED.
- IMPACT AND FATIGUE RESISTANCE HAS BEEN DETERMINED IN ACCORDANCE WITH THE FBC SECTION 1609.1.2. LARGE MISSILE AS LISTED HEREIN.
- NO 33-1/3% INCREASE IN ALLOWABLE STRESS INCREASE HAS BEEN USED IN THE DESIGN OF THIS PRODUCT. A 1.6 WIND LOAD DURATION FACTOR WAS USED TO CALCULATE SCREW SPACINGS FOR LAG SCREWS INTO WOOD.
- THIS PRODUCT EVALUATION DOCUMENT (PED) DETAILED HEREIN IS GENERIC AND DOES NOT PROVIDE INFORMATION FOR A SPECIFIC SITE. IF SITE CONDITIONS DEVIATE FROM THE CONDITIONS DETAILED HEREIN, A LICENSED ENGINEER OR REGISTERED ARCHITECT SHALL PREPARE SITE SPECIFIC DOCUMENTS TO BE USED IN CONJUNCTION WITH THIS DOCUMENT.
- THE CONTRACTOR AND / OR PERMIT HOLDER IS TO BE RESPONSIBLE FOR THE SELECTION, PURCHASE AND INSTALLATION OF THIS SYSTEM, INCLUDING VERIFYING THE ADEQUACY OF THE EXISTING STRUCTURE TO WITHSTAND THE NEW SUPERIMPOSED LOADS SHOWN BELOW AND THE SOUNDNESS OF THE STRUCTURE WHERE THE SYSTEM IS TO BE ATTACHED TO ENSURE PROPER ANCHORAGE.
- SITE SPECIFIC PROJECTS SHALL BE PREPARED BY A FLORIDA LICENSED ENGINEER OR ARCHITECT WHO WILL BECOME THE ENGINEER OF RECORD (EOR) FOR THE PROJECT AND WHO WILL BE RESPONSIBLE FOR THE PROPER USE OF THE PED. THE ENGINEER OF RECORD, ACTING AS A DELEGATED ENGINEER TO THE PED ENGINEER SHALL SUBMIT TO THIS ENGINEER THE SITE SPECIFIC DRAWINGS FOR REVIEW.
- THIS PED SHALL BEAR THE DATE AND ORIGINAL SEAL OF THE PROFESSIONAL ENGINEER OF RECORD THAT PREPARED IT REGARDLESS OF ITS AVAILABILITY FROM THE FLORIDA PRODUCT APPROVAL WEBSITE.
- THIS SYSTEM MAY ALSO BE INSTALLED HORIZONTALLY FOLLOWING INSTALLATION DETAILS SHOWN HEREIN.
- PANELS MAY BE MOUNTED INSIDE AND/OR OUTSIDE THE BUILDING ENVELOPE.
- CORRUGATED PANEL LIMITATIONS OF USE:
THE MAXIMUM SIZE SHALL BE 25 PSF MAX. PRESSURE @135 INCHES MAXIMUM WIDTH (CENTER / CENTER OF WALL FASTENERS). SEE TABLES ON SHEET 2 OF 10.
- FLAT PANEL LIMITATIONS OF USE:
THE MAXIMUM ALLOWABLE DESIGN PRESSURES ARE: +60PSF/-60PSF. SEE TABLES ON SHEET 2 OF 10.
- FOR DETERMINING INTERNAL PRESSURE IN THE ABOVE REFERENCED CODES, THIS PRODUCT IS CLASSIFIED AS NON-POROUS WITH A POROSITY OF LESS THAN 10% FOR THE CONDITIONS SHOWN IN THIS PRODUCT EVALUATION DOCUMENT. CLEAR PANELS MUST COMPLETELY COVER AN OPENING IN ALL DIRECTIONS. SEE END CAP BUILD OUT DETAIL ON SHEET 8 OF 10.
- ALL SCREWS TO BE STAINLESS STEEL 304 OR GALVANIZED A307 STEEL. ALL BOLTS TO BE ASTM A307, GALVANIZED OR 304 SERIES STAINLESS STEEL.
- PANEL OR PANELS CAN BE USED ADJACENT TO OTHER APPROVED CORRUGATED SYSTEMS.
- SUPPORTBRACKETS AND ANCHORS:
A. ANCHORS INTO THE SUPPORT SUBSTRUCTURE (WALL, CEILINGS, BEAMS AND FLOORS) SHALL BE INSTALLED PER MANUFACTURER'S REQUIREMENTS.
B. THE ANCHOR SPACING SHOWN ON SHEETS 2, 6, 7, 8 & 9 OF 10, INDICATED FOR 1/4" and 3/8" DIAMETERS REFER TO CENTER OF SUPPORTING BRACKETS.
C. THE ANCHOR SPACING CHARTS ARE BASED ON A REMOVAL BRACKET SYSTEM USING MALE PANELMATES WITH WINGNUTS, FEMALE PANELMATES, SAMANY'S AND DROP-IN ANCHORS WITH SIDEWALK BOLTS. TAPCONS OF THE SAME SIZE MAY BE SUBSTITUTED FOR PERMANENT BRACKET INSTALLATIONS. ITW MAXI-SET TAPCONS MAY BE USED.
D. ANCHOR MINIMUM EMBEDMENT AND EDGE DISTANCES OF ELCO ULTRACONS, ITW TAPCONS OR ALL POINTS TAPCONS.

SUBSTRUCTURE	EMBEDMENT	EDGE DISTANCE
HOLLOW BLOCK	1-1/4" NCH	12 D OR PER MANUFACTURER'S SPECIFICATIONS
CONCRETE	1-3/4" NCH	12 D OR PER MANUFACTURER'S SPECIFICATIONS
4 KSI CONCRETE OR 2 KSI CONCRETE	1-3/4" NCH	12 D OR PER MANUFACTURER'S SPECIFICATIONS
WOOD OR DIMBER	8 D	3/4" NCH

- NO EMBEDMENT INTO NON-STRUCTURAL MATERIAL SUCH AS STUCCO, SIDING AND PAVERS SHALL BE INCLUDED AS PART OF THE EMBEDMENT REQUIREMENT.
- STEEL SURFACES TO BE PLACED IN CONTACT WITH ALUMINUM SHALL BE GIVEN ONE COAT OF ZINC CHROMATE PRIMER IN ACCORDANCE WITH FEDERAL SPEC NO.: TTP-645, OR BE GALVANIZED.
- MAXIMUM DESIGN PRESSURE VERSUS PANEL SPAN SHOWN ON SHEET 2 OF 10. INTERPOLATION IS ALLOWED IN BETWEEN TWO SPANS TO OBTAIN SPACINGS NOT LISTED.
- ALL ALUMINUM ALLOYS SHALL BE 6063-T6, 6061-T5, 6061-T6 OR 6005-T5.
- ANCHORING OR LOADING CONDITIONS OTHER THAN THOSE SHOWN IN THESE DETAILS ARE NOT PART OF THIS APPROVAL.
- TRACKS MAY BE CURVED TO FOLLOW THE INSTALLATION PROFILE AROUND ARCHES AND RADIII.
- PANEL'S MANUFACTURER LABEL SHALL BE PLACED ON A READILY AND VISIBLE LOCATION ON THE PANEL. ONE LABEL SHALL BE PLACED FOR EVERY OPENING.
LABEL SHALL READ AS FOLLOWS:
ULTRATEK WORLDWIDE
3801 N. Washington Blvd.
Sarasota, FL 34234

23. THIS DOCUMENT IN ITS ENTIRETY WILL BE CONSIDERED INVALID IF IT IS ALTERED BY ANY MEANS OR DOES NOT BEAR THE DATE AND ORIGINAL SEAL OF THE PROFESSIONAL ENGINEER OF RECORD THAT PREPARED IT.

POLYCARBONATE SOURCES		RESULT	
TYPICAL PROPERTIES	STANDARD	SABIC LEXAN 100 RESIN	BYER MARBOLON 3003
MECHANICAL			
TENSILE YIELD STRENGTH	ASTM D638	9.5 ksi	9.4 ksi
FLEXURAL STRENGTH AT YIELD	ASTM D790	12.5 ksi	12.5 ksi
FLEXURAL MODULUS	ASTM D790	345 ksi	340 ksi
IMPACT:			
NOTCHED IZOD	ASTM D256	17 ft-lb/in	18 ft-lb/in
FIRE BURNING CHARACTERISTICS:			
SMOKE DENSITY	ASTM D2843	64.5% MAX.	47.20%
RATE OF BURNING	ASTM D635	C-1 CLASS	C-1 CLASS
SELF IGNITION	ASTM D1929	980 deg. F	1040 deg. F
WEATHERING:			
TENSILE STRENGTH AFTER WEATHERING	ASTM G155	8,940 ksi	9,302 ksi
TENSILE STRESS BEFORE WEATHERING	ASTM G38	8,880 ksi	8,461 ksi
PHYSICAL:			
SPECIFIC GRAVITY	ASTM D792	0.043 lb/in ³	0.043 lb/in ³

- TEST REPORTS**
- UNIFORM STATIC AIR PRESSURE (TAS 202, E330-02)
- HETI 07-4198 04/30/2007
 - HETI 07-4202/32 04/30/2007
 - HETI 07-4252 06/13/2007
 - HETI 07-4285 07/27/2007
 - HETI 08-2048/50/52 10/10/2008
 - HETI 09-2507A 01/28/2009
 - HETI 09-2508A 01/28/2009
 - B9069-01-401-18 04/26/2012
 - BT-ULTK-13-001A 09/24/2013
 - BT-ULTK-13-001B 09/24/2013
 - BT-ULTK-15-001 04/30/2015

- LARGE MISSILE & CYCLIC LOADING (TAS 201, TAS 203)**
- HETI 07-4199/04/05 04/30/2007
 - HETI 07-4233/54 04/30/2007
 - HETI 07-4233/86 07/27/2009
 - HETI 08-2049 10/10/2008
 - HETI 09-2507B 01/28/2009
 - HETI 09-2508B 01/28/2009
 - B9069-01-401-18 04/26/2012
 - BT-ULTK-13-001A 09/24/2013 plus ASTM E1886-02, E1996-02
 - BT-ULTK-13-001B 09/24/2013 plus ASTM E1886-02, E1996-02
 - BT-ULTK-15-001 04/30/2015

- TENSILE TEST (ASTM D638-03)**
- HETI 07-1750 09/07/2007
 - HETI 09-1104/05 01/28/2009
- EVALUATION BASED ON:**
ARCHITECTURAL TESTING INC.
- REPORT NO.:** 85233-01-401-44
REPORT DATE: 12-21-2011
TEST PROTOCOL: ASTM E 1886-05 (IMPACT & CYCLIC TEST METHOD)
ASTM E 1996-05 (IMPACT STANDARD SPECIFICATION)
ASTM E 330-02 (STATIC TEST METHOD)
ASTM E 330-02 (STATIC TEST METHOD)
DESIGN PRESSURE: 60 PSF W/ MISSILE LEVEL D AND WIND ZONE 4.
TEST PRESSURE: 90 PSF
OVERALL SPAN: 9'-1" (109 INCHES)

- EVALUATION BASED ON:**
ARCHITECTURAL TESTING INC.
- REPORT NO.:** A3398-01-401-44
REPORT DATE: 09/08/10
TEST PROTOCOL: ASTM E 1886-05 (IMPACT & CYCLIC TEST METHOD)
ASTM E 1996-05 (IMPACT STANDARD SPECIFICATION)
ASTM E 330-02 (STATIC TEST METHOD)
DESIGN PRESSURE: 60 PSF W/ MISSILE LEVEL D AND WIND ZONE 4.
TEST PRESSURE: 90 PSF
OVERALL SPAN: 9'-1" (109 IN.)
CTR/CTR FASTENERS: 8'-9" (105 IN.) INSIDE TO INSIDE FRAME.



CA #6752
WWW.MEAENGINEERS.COM

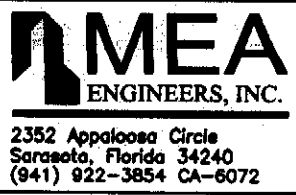

<p>Project Name: Ultratek Worldwide Inc. 3801 N. Washington Blvd. Sarasota, FL 34234 PHONE: (941) 924-2285 www.ultratekworldwide.com</p>	<p>REV. 1</p>	<p>DESCRIPTION XX/XX/XX - RESERVED.</p>
	<p>Project No.: JK Date: 4/30/15 NOTED</p>	<p>Project #15-50</p>

CLEARTEK STORM PANEL SYSTEM (HVHZ)

1/10

CORRUGATED PANEL TABLES

FLAT PANEL TABLES

CORRUGATED

SPAN LOAD TABLE	
DIRECT MOUNT PANELS AT BOTH ENDS	
MAX. SPAN - IN.	MAX. DESIGN LOAD
60'	75.0
72'	60.0
84'	55.0
96'	52.0
108'	35.0
120'	32.0
132'	30.0
135'	25.0

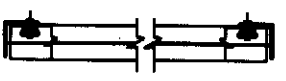

MOUNT WITH FASTENERS AT MAX. 13 INCH O.C.

CORRUGATED

SPAN LOAD TABLE	
DIRECT MOUNT PANELS AT ONE END ONLY	
MAX. SPAN - IN.	MAX. DESIGN LOAD
60'	60.0
72'	50.0
84'	45.0
96'	40.0
102'	22.0



DESIGN PRESSURE 30 PSF	Span(ft.)	4000 PSI CONCRETE		2000 PSI CONCRETE		HOLLOW BLOCK		WOOD	
		1/4" FASTENERS	3/8" FASTENERS	1/4" FASTENERS	3/8" FASTENERS	1/4" FASTENERS	3/8" FASTENERS	1/4" FASTENERS	3/8" FASTENERS
105	105	11	11	11	11	8	10	9	7
		86	11	11	11	11	11	11	11
67	48	11	11	11	11	11	11	11	11
		48	11	11	11	11	11	11	11
105	105	11	11	11	11	11	11	10	10
		86	11	11	11	11	11	11	11
67	48	11	11	11	11	11	11	11	11
		48	11	11	11	11	11	11	11

DESIGN PRESSURE 40 PSF	Span(ft.)	4000 PSI CONCRETE		2000 PSI CONCRETE		HOLLOW BLOCK		WOOD	
		1/4" FASTENERS	3/8" FASTENERS	1/4" FASTENERS	3/8" FASTENERS	1/4" FASTENERS	3/8" FASTENERS	1/4" FASTENERS	3/8" FASTENERS
105	105	10	11	9	7	7	8	7	6
		86	11	11	11	10	10	9	9
67	48	11	11	11	11	11	11	11	11
		48	11	11	11	11	11	11	11
105	105	11	11	11	11	11	11	8	8
		86	11	11	11	11	11	10	10
67	48	11	11	11	11	11	11	11	11
		48	11	11	11	11	11	11	11

DESIGN PRESSURE 60 PSF	Span(ft.)	4000 PSI CONCRETE		2000 PSI CONCRETE		HOLLOW BLOCK		WOOD	
		1/4" FASTENERS	3/8" FASTENERS	1/4" FASTENERS	3/8" FASTENERS	1/4" FASTENERS	3/8" FASTENERS	1/4" FASTENERS	3/8" FASTENERS
105	105	9	10	8	9	6	7	5	6
		86	11	11	11	11	11	11	11
67	48	11	11	11	11	11	11	11	10
		48	11	11	11	11	11	11	11
105	105	11	11	11	11	11	11	7	8
		86	11	11	11	11	11	11	10
67	48	11	11	11	11	11	11	11	11
		48	11	11	11	11	11	11	11

DESIGN PRESSURE 60 PSF	Span(ft.)	4000 PSI CONCRETE		2000 PSI CONCRETE		HOLLOW BLOCK		WOOD	
		1/4" FASTENERS	3/8" FASTENERS	1/4" FASTENERS	3/8" FASTENERS	1/4" FASTENERS	3/8" FASTENERS	1/4" FASTENERS	3/8" FASTENERS
105	105	7	9	7	8	5	6	4	5
		86	11	11	11	10	10	9	9
67	48	11	11	11	11	11	11	11	11
		48	11	11	11	11	11	11	11
105	105	11	11	11	11	11	11	6	7
		86	11	11	11	11	11	11	9
67	48	11	11	11	11	11	11	11	11
		48	11	11	11	11	11	11	11

- STORM BARS FOR WIND ZONE 4 AND ESSENTIAL FACILITIES**
1. STORM BARS REQUIRED 12" FROM EDGE AND EVERY 18" IN THE FIELD.
 2. LENGTH OF STORM BARS SAME AS LENGTH OF PANELS.
 3. MAXIMUM OPENING SIZE IS 80 INCHES.
 4. MAXIMUM PRESSURE IS 60 PSF.
 5. WITH ABOVE CRITERIA, MAXIMUM DEFLECTION IS 0.85 INCHES. PANEL IS TO BE INSTALLED NO CLOSER THAN 2 INCHES FROM GLAZING.
 6. STORM BARS (2"x2"x1/8" RECT. TUBE) FIT IN CORRUGATION BETWEEN PANEL AND BUILDING AND ARE TO BE USED ONLY WITH ALTERNATE "A" CORRUGATED PANEL SHOWN ON SHT. 5 OF 10.

- GLASS SEPARATION SCHEDULE NOTES:**
- 1) GLASS SEPARATION SCHEDULE PROVIDES MINIMUM SEPARATION DISTANCE REQUIRED BETWEEN EXTERIOR FACE OF GLAZING (OR OTHER PRODUCT BEING PROTECTED) AND INTERIOR FACE OF INSTALLED STORM PANEL.
 - 2) SEPARATION DISTANCE PER THIS SCHEDULE IS REQUIRED FOR USE WITH POSITIVE LOADS ONLY.
 - 3) SIDE BRACKET IS AN EXTRA BRACKET ADDED HALFWAY ACROSS SPAN ON BOTH SIDES.

LAG-WOOD	SAMMY (GST)-WOOD	PANEL MATE (MALE FASTENER)	PANEL MATE (FEMALE)	SIDEWALK BOLTS FASTENAL 1/4-20X1 FASTENAL 3/8-16X1	POWERS HOLLOW SET DROP-IN OR LEAD ANCHOR
WINNUT-PATFEND	SAMMY (GST) CONG.	ALL POINTS/TW BUILD EX TAPCON ANCHOR INCLUDING: MAXISET, SCOTS, 410SS	POWERS FLANGED LIP DROP-IN	POWERS SMOOTH WALL DROP-IN	PANELMATE INSERT

TYPICAL FASTENERS/ANCHORS - 1/4" AND 3/8" N.T.S. 1

Positive Load (psf)	Span Less Than	Minimum Separation from Glass	Minimum Separation from Glass With Side Bracket (See Note 3)
30	49"	2.25"	2.25"
40	49"	2.25"	2.25"
50	49"	2.25"	2.25"
60	49"	2.25"	2.25"

Direct Mount Panels at One End Only	Max. Span - In.	Min. Separation
60	60	6.125
72	72	6.56
84	84	7
96	96	7.06
102	102	7.125

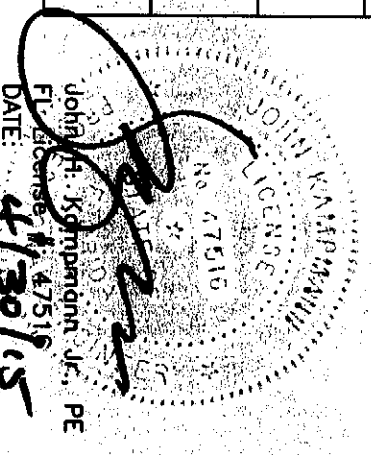

Project Name: **Ultratek Worldwide Inc.**
 3801 N. Washington Blvd.
 Sarasota, FL 34234
 PHONE: (941) 924-2285
 www.ultratekworldwide.com

REV.	DESCRIPTION
1	XX/XX/XX - RESERVED.

CA #6752
 WWW.MEAENGINEERS.COM
MEA ENGINEERS, INC.
 2352 Appaloosa Circle
 Sarasota, Florida 34240
 (941) 922-3854 CA-8072

CLEARTEK STORM PANEL SYSTEM (HVHZ)

2/10
 NOTED
 4/30/15

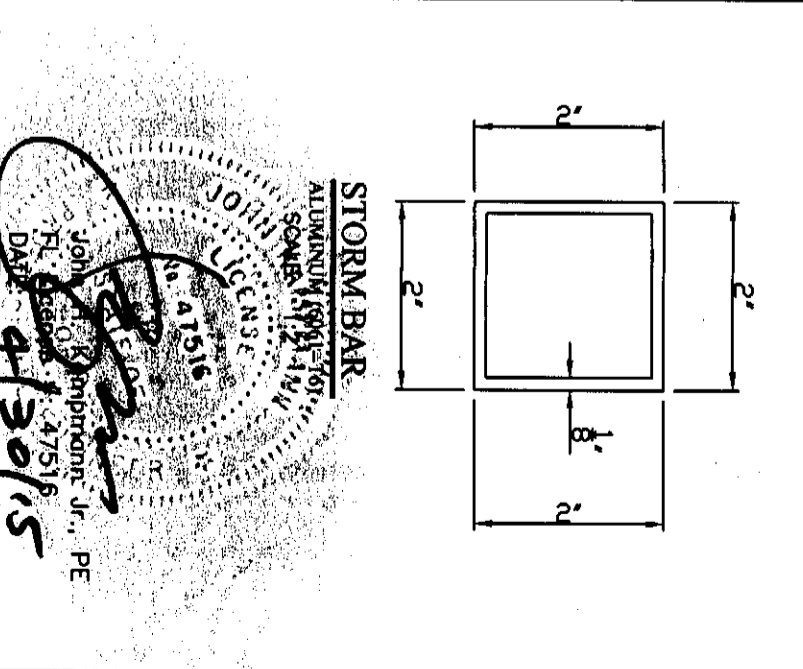
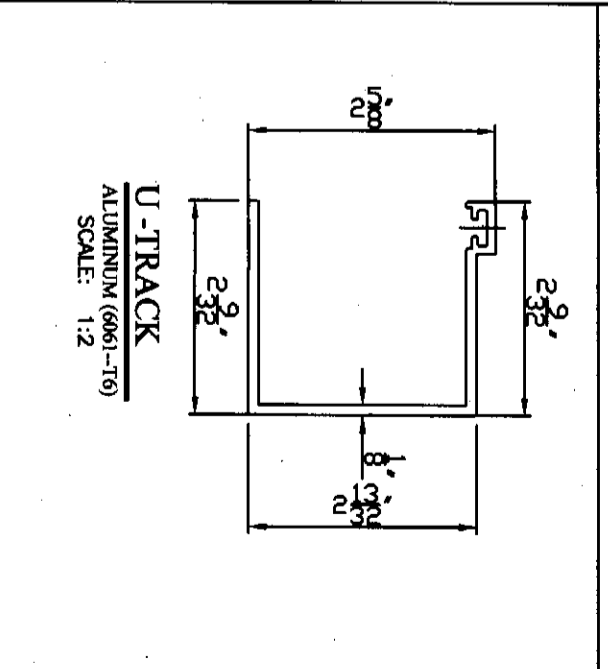
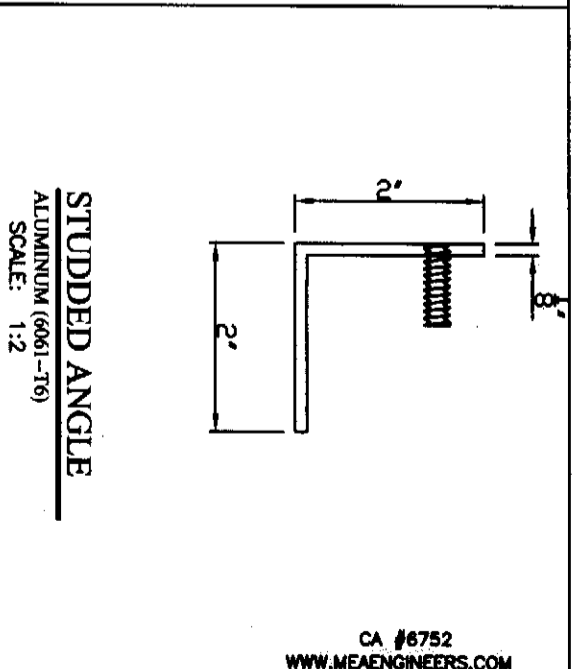
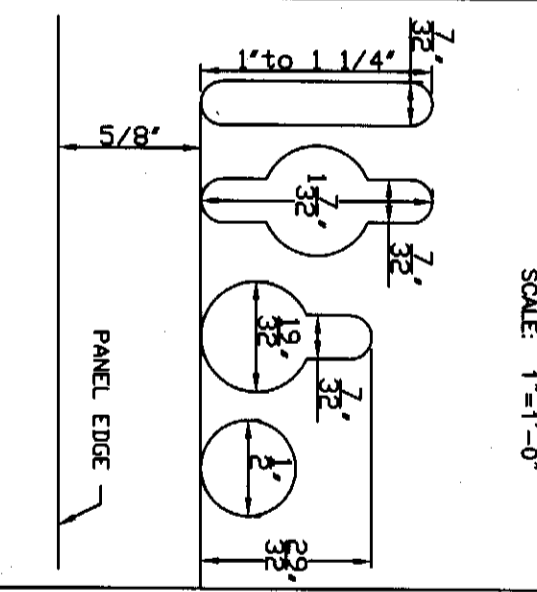
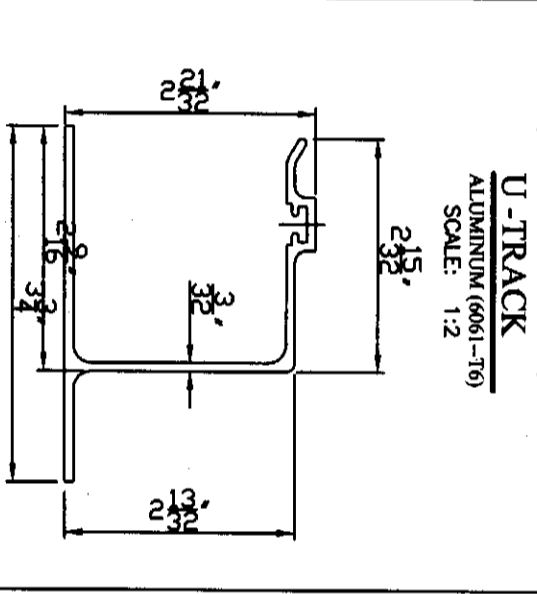
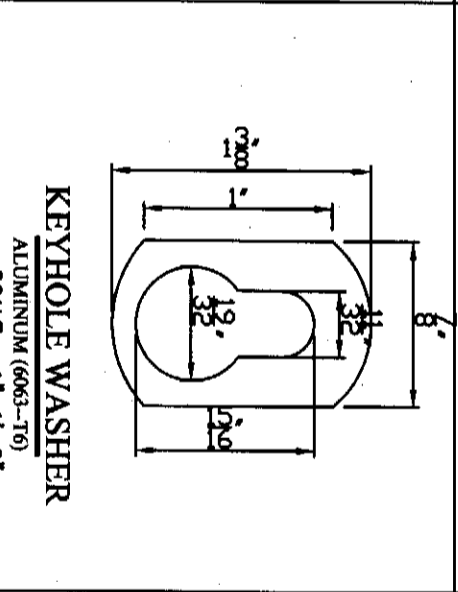
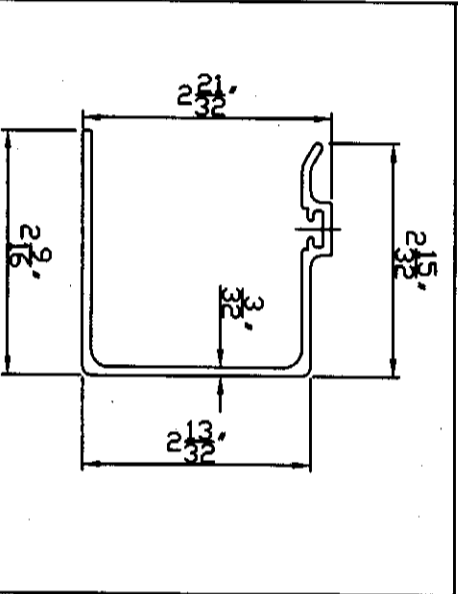
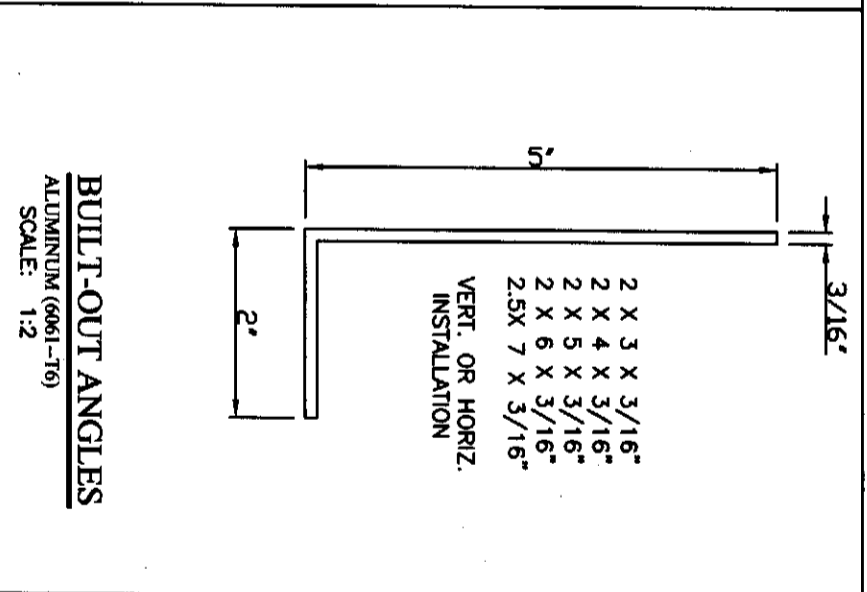
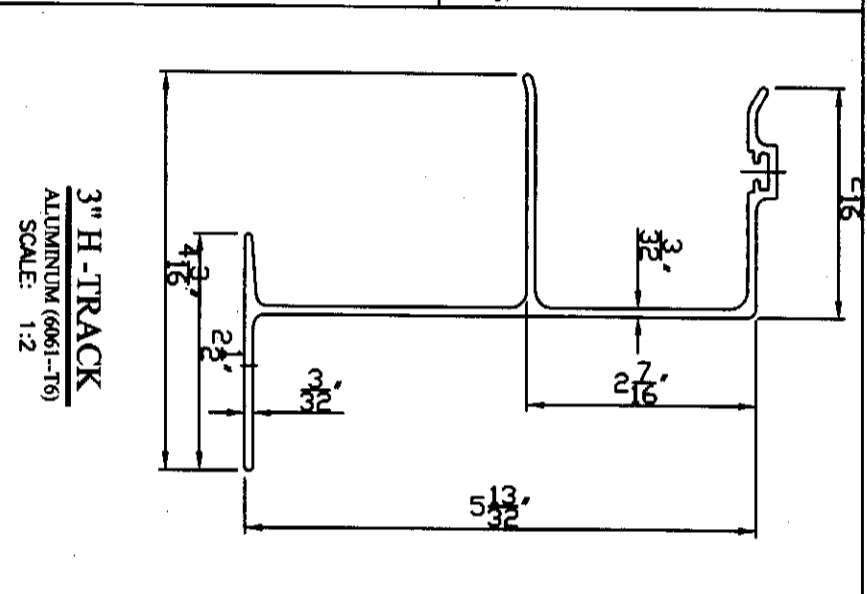
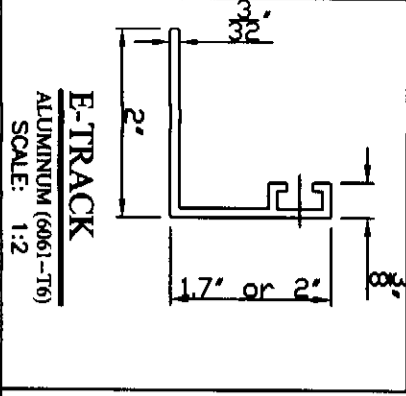
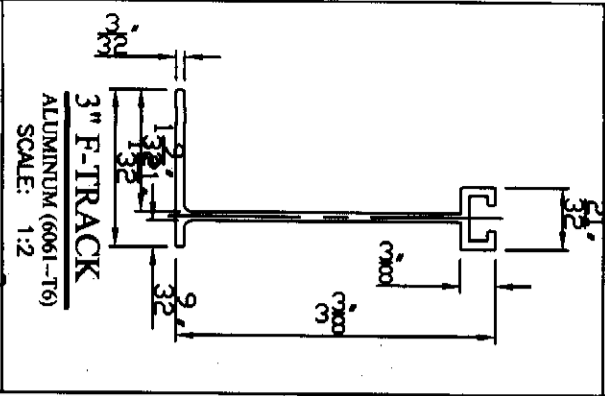
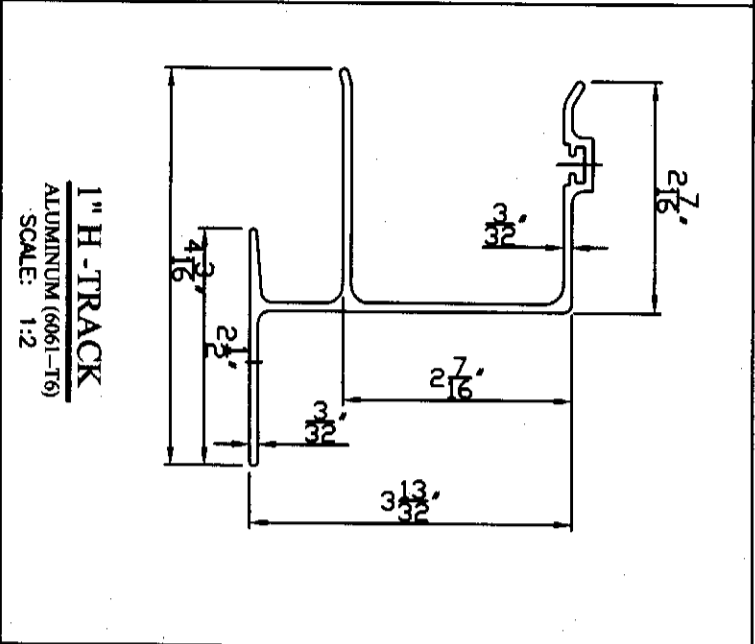
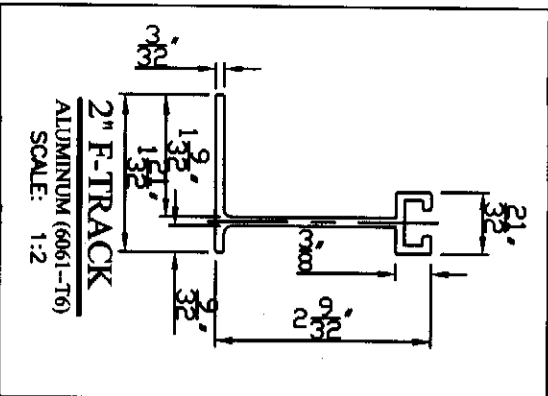
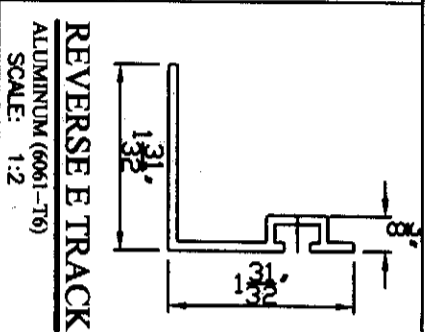
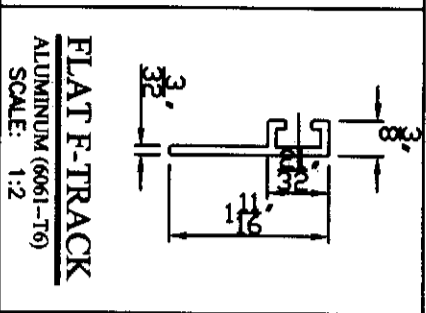
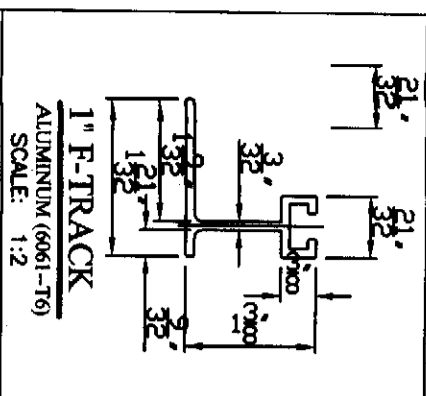

CA #6752
WWW.MEAENGINEERS.COM

MEA
ENGINEERS, INC.
2352 Appaloosa Circle
Sarasota, Florida 34240
(941) 922-3854 CA-6072

REV.	DESCRIPTION
1	XX/XX/XX - RESERVED.

Project Name: **Ultratek Worldwide Inc.**
3801 N. Washington Blvd.
Sarasota, FL 34234
PHONE: (941) 924-2285
www.ultratekworldwide.com

Description: **CLEARTEK
STORM PANEL SYSTEM
(HVHZ)**

Notes:
JK
Project # 15-50
NOTED
4/30/15
3/10

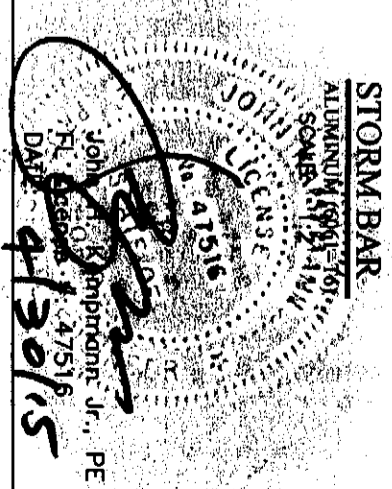

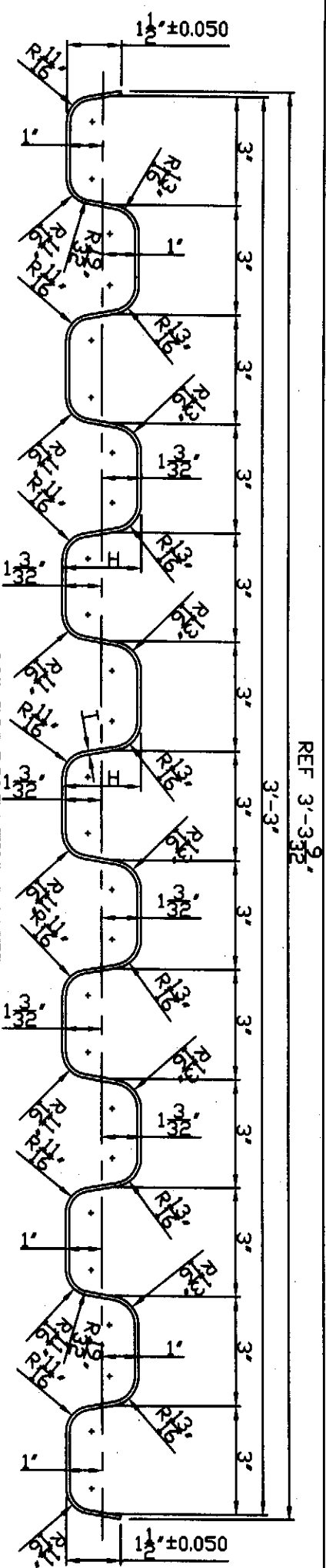

39" CORRUGATED PANEL
(GE LEXAN 103/BAYER MAKROLON 3103/POLYONE/SPARTECH)
Fu = 9367 PSI, Fy = 91346 PSI
SCALE: 3" = 1'-0"

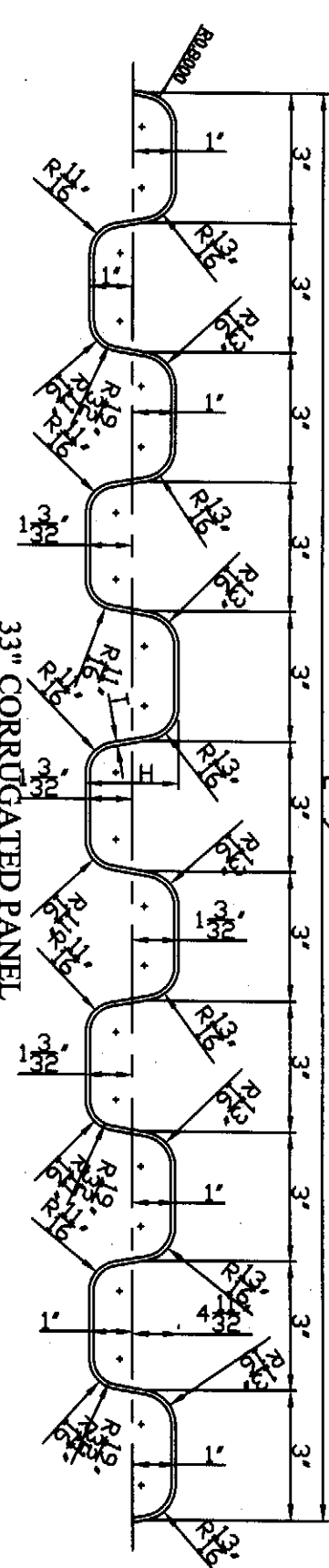

33" CORRUGATED PANEL
(GE LEXAN 103/BAYER MAKROLON 3103/POLYONE/SPARTECH)
Fu = 9367 PSI, Fy = 91346 PSI
SCALE: 3" = 1'-0"

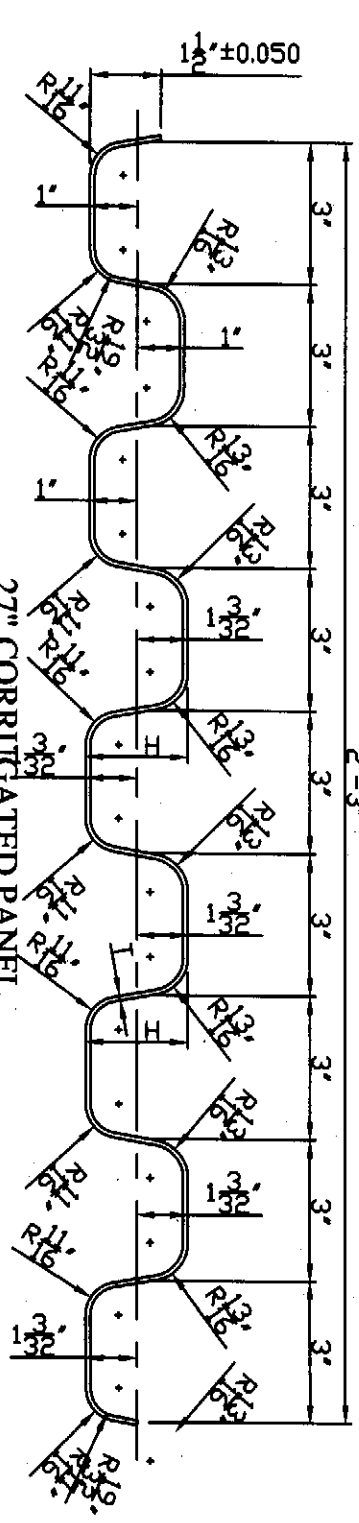

27" CORRUGATED PANEL
(GE LEXAN 103/BAYER MAKROLON 3103/POLYONE/SPARTECH)
Fu = 9367 PSI, Fy = 91346 PSI
SCALE: 3" = 1'-0"

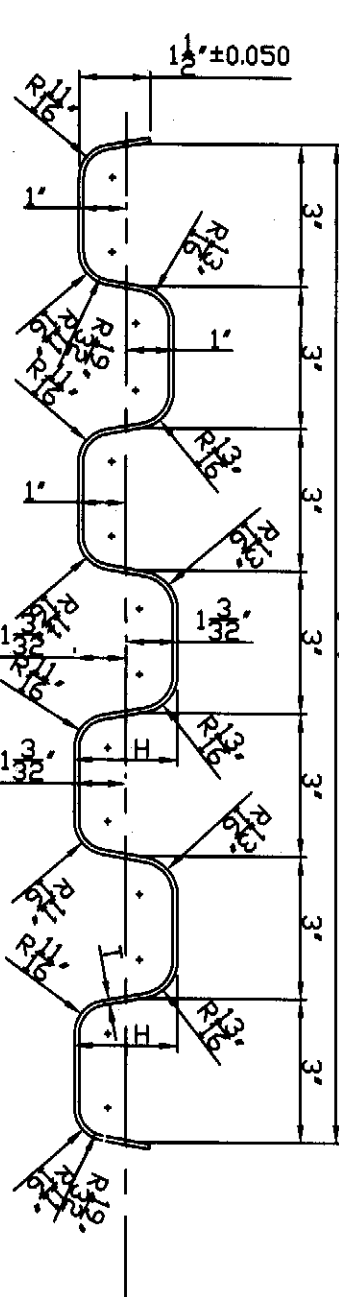

21" CORRUGATED PANEL
(GE LEXAN 103/BAYER MAKROLON 3103/POLYONE-SINGUARD)
Fu = 9367 PSI, Fy = 91346 PSI
SCALE: 3" = 1'-0"

- NOTE:
- 1) THICKNESS: 2.36 mm TO 2.50 mm ±0.05
 - 2) MATERIAL: (GE LEXAN 103/BAYER MAKROLON 3103/POLYONE-SINGUARD)
 - 3) THE DIMENSION 'H' MUST BE 53.3 ~ 55.0 mm
 - 4) ALL INCLINED PLANE THE THICKNESS 'T' MUST BE MINIMUM 2.10 mm
 - 5) PANELS MAY BE BENT ALONG CORRUGATION TO MATCH CURVED OR ANGLED OPENINGS
 - 6) PANEL RADII MAY VARY BETWEEN 0.1 TO 0.6in.
 - 7) ALL PANELS MAY BE CUT TO DECREASE ITS WIDTH.
 - 8) TRACK MAY BE CURVED TO FOLLOW THE INSTALLATION PROFILE AROUND ARCHES AND RADII.
 - 9) HEIGHT OF WAIVE MAY VARY DOWN TO 0.75 INCH.
 - 10) PANELS MAY BE BENT OR CURVED TO ACCOMMODATE CURVED OR MITERED GLASS
 - 11) PANEL WIDTH MAY VARY BY 5%.

JOHN KAMPPEN, JR., PE
FL. LIC. # 17519
DATE: 4/30/15

Project # 15-50 Date: 4/30/15 4/10	Description: CLEARTEK STORM PANEL SYSTEM (HVHZ)	Project Name: Ultratek Worldwide Inc. 3801 N. Washington Blvd. Sarasota, FL 34234 PHONE: (941) 924-2285 www.ultratekworldwide.com	<table border="1"> <thead> <tr> <th>REV.</th> <th>DESCRIPTION</th> </tr> </thead> <tbody> <tr> <td>1</td> <td>XX/XX/XX - RESERVED.</td> </tr> </tbody> </table>	REV.	DESCRIPTION	1	XX/XX/XX - RESERVED.	CA #6752 WWW.MEAENGINEERS.COM 2352 Appaloosa Circle Sarasota, Florida 34240 (941) 822-3854 CA-6072
REV.	DESCRIPTION							
1	XX/XX/XX - RESERVED.							

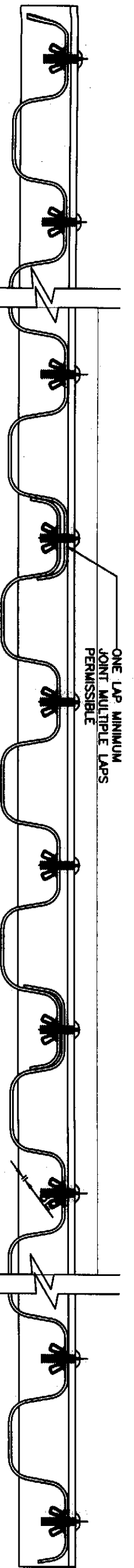

SECTION E-E
SCALE: 3" = 1'-0"

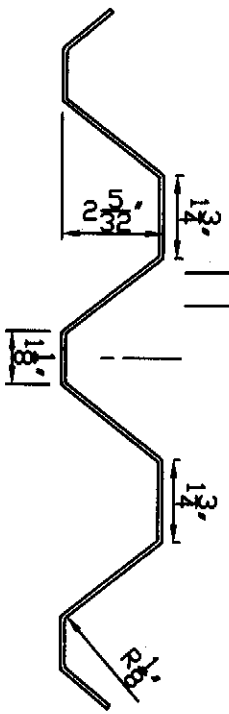

ALTERNATE "A" 12" CORRUGATED PANEL
(GE LEXAN 103/BAYER MAKROLON 3103/POLYONE/SPARTECH)
Fu = 9367 PSI, Fy = 91346 PSI
SCALE: 3" = 1'-0"

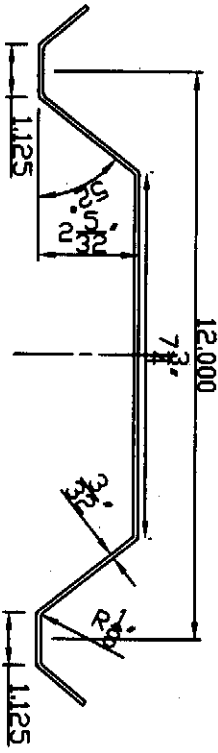

ALTERNATE "B" 12" CORRUGATED PANEL
(GE LEXAN 103/BAYER MAKROLON 3103/POLYONE/SPARTECH)
Fu = 9367 PSI, Fy = 91346 PSI
SCALE: 3" = 1'-0"

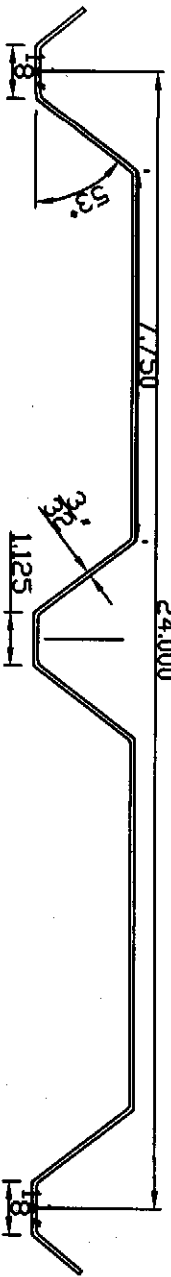

ALTERNATE "C" 24" CORRUGATED PANEL
(GE LEXAN 103/BAYER MAKROLON 3103/POLYONE/SPARTECH)
Fu = 9367 PSI, Fy = 91346 PSI
SCALE: 3" = 1'-0"

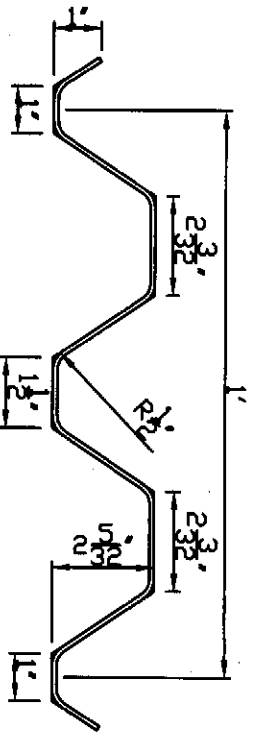

ALTERNATE "D" 24" CORRUGATED PANEL
(GE LEXAN 103/BAYER MAKROLON 3103/POLYONE/SPARTECH)
Fu = 9367 PSI, Fy = 91346 PSI
SCALE: 3" = 1'-0"

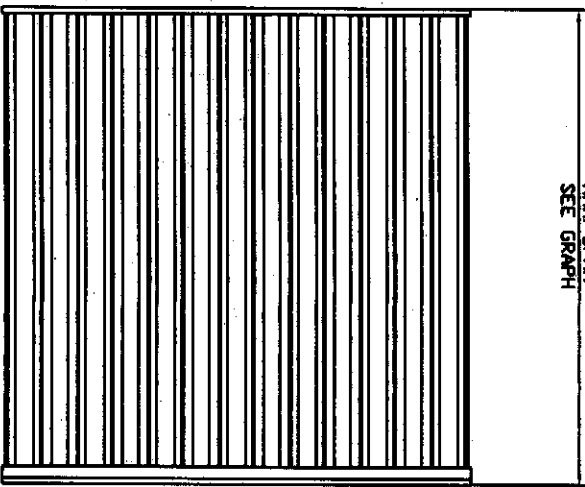
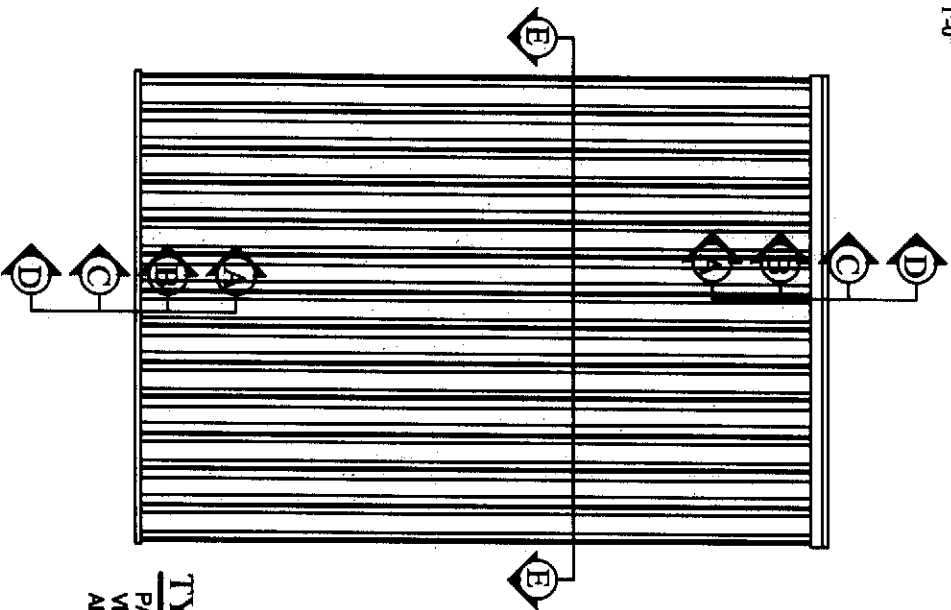

TYPICAL ELEVATION
PANELS CAN BE INSTALLED
VERTICALLY OR HORIZONTALLY USING
APPLICABLE ANCHORING DETAILS

ALTERNATE PANEL NOTE:

1) ALTERNATE PANEL 'B' AND 'C' MAY ONLY BE
USED AS A DIRECT MOUNT AT BOTH ENDS.

CA #6752
WWW.MEAENGINEERS.COM



2352 Appalosa Circle
Sarasota, Florida 34240
(941) 822-3854 CA-6072

REV.	DESCRIPTION
1	XX/XX/XX - RESERVED.

Ultratek Worldwide Inc.
3801 N. Washington Blvd.
Sarasota, FL 34234
PHONE: (941) 924-2285
www.ultratekworldwide.com

CLEARTEK
STORM PANEL SYSTEM
(HVHZ)

Project Name:

Description:

JK

NOTED

4/30/15

5/10

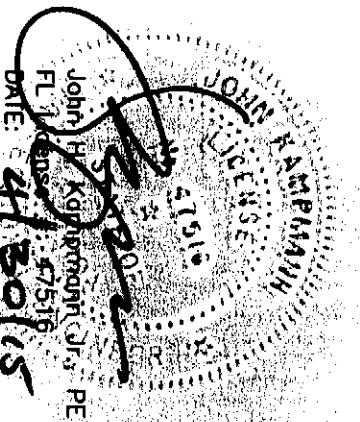

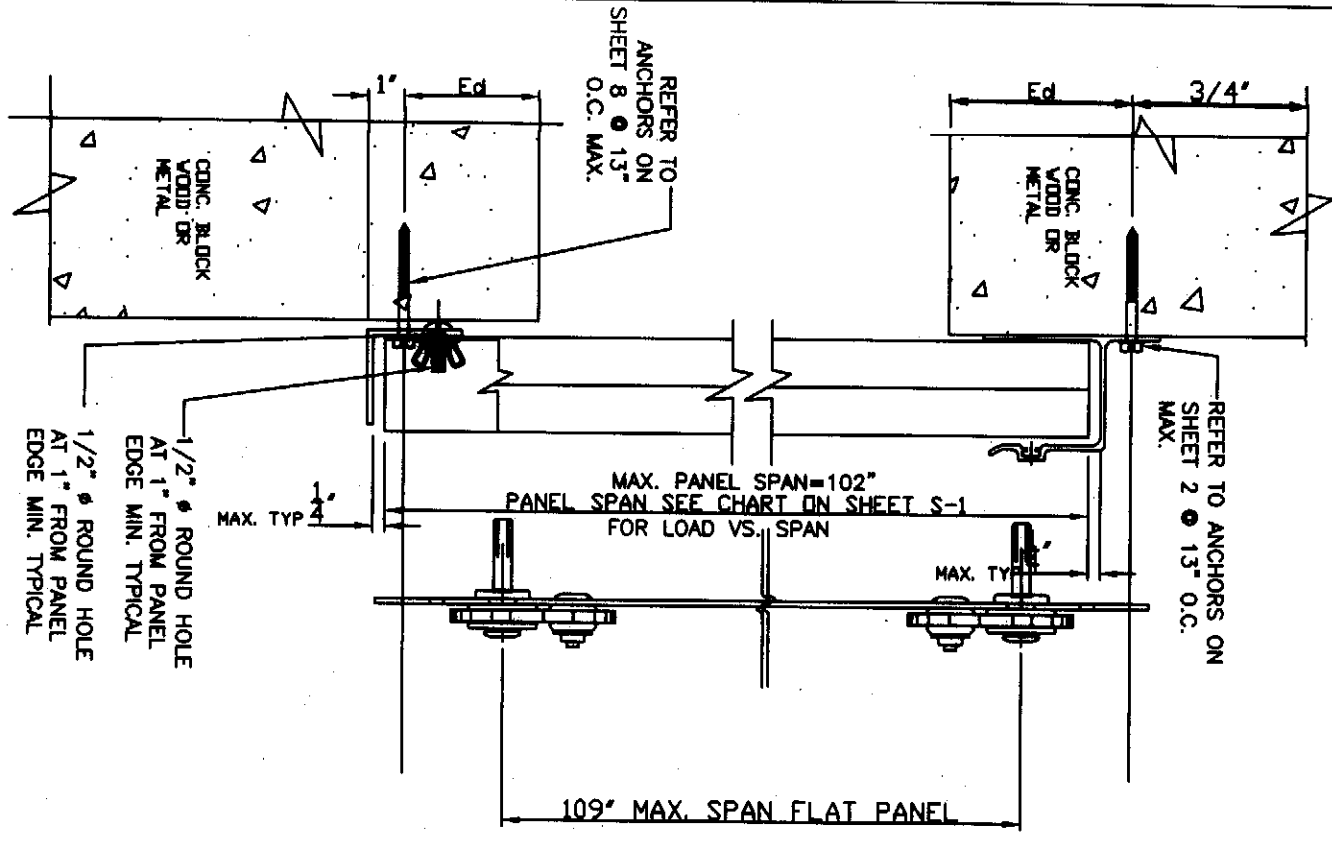

SECTION A-A

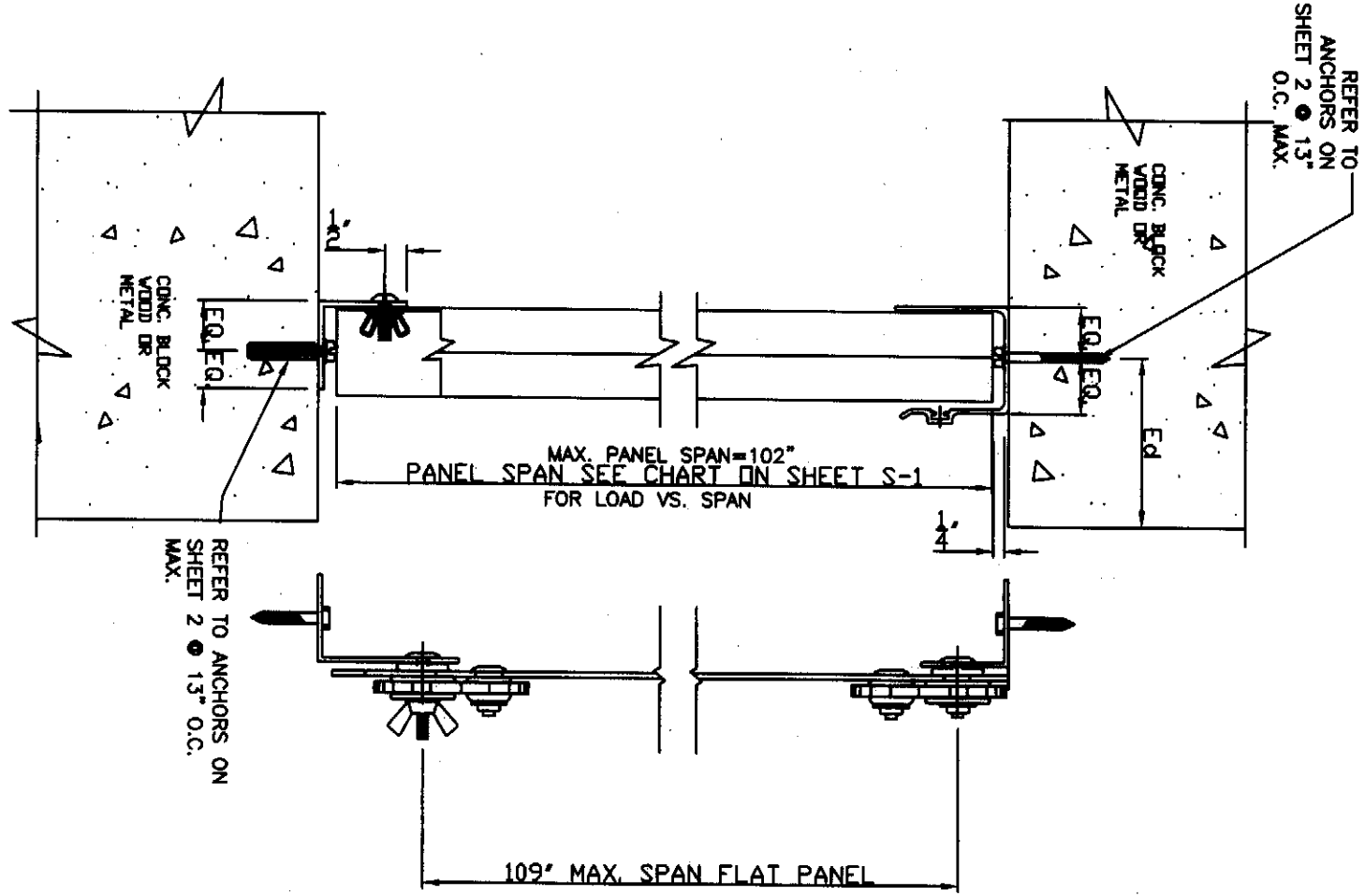

SECTION B-B

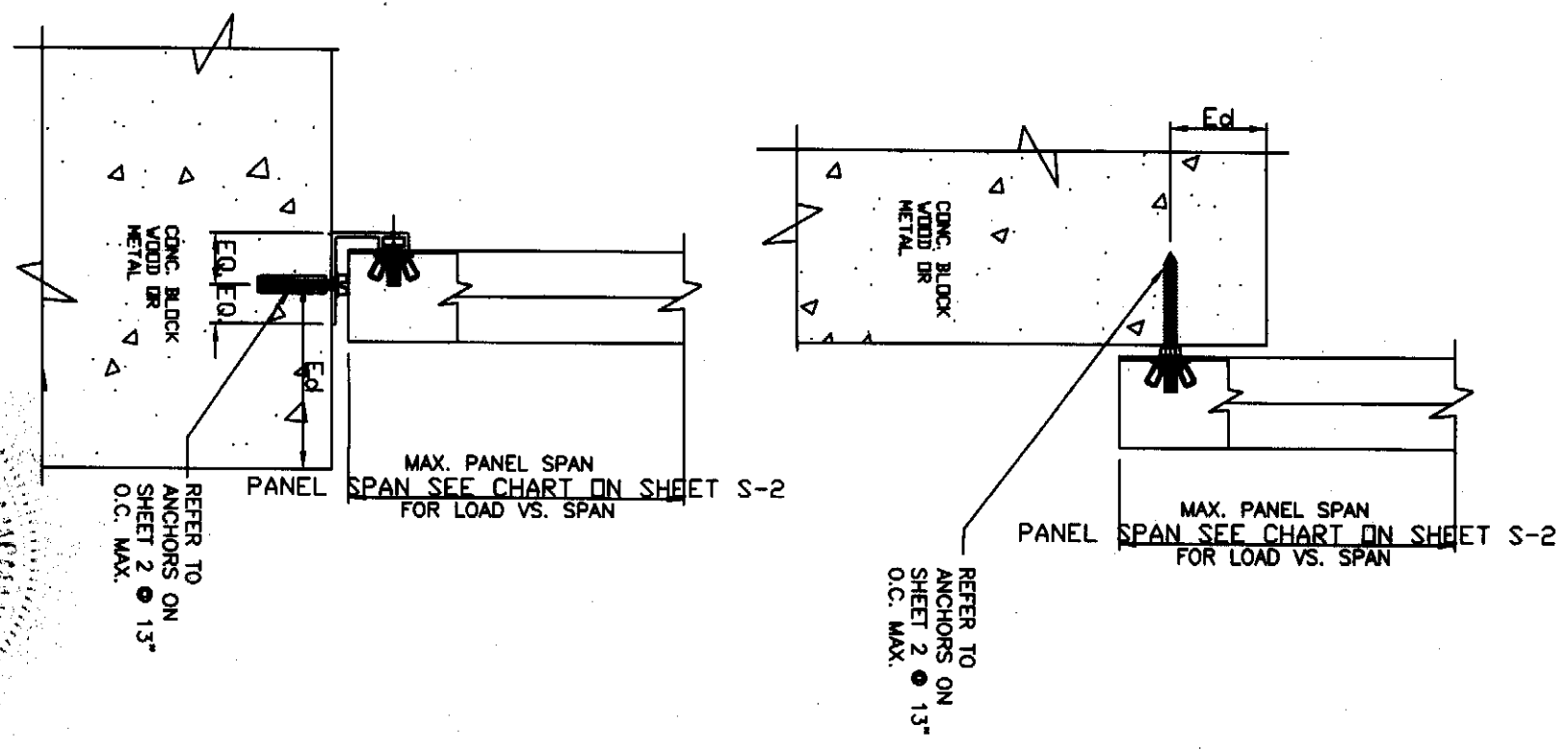

SECTION C-C

John H. Dimpert, Jr., PE
 FL License No. 1516
 DATE: 4/30/15

6/10
 Project # 15-50
 NOTED
 4/30/15

Description:
**CLEARTEK
 STORM PANEL SYSTEM
 (HVHZ)**

Project Name:
Ultratek Worldwide Inc.
 3801 N. Washington Blvd.
 Sarasota, FL 34234
 PHONE: (941) 924-2285
 www.ultratekworldwide.com

REV.	DESCRIPTION
1	XX/XX/XX - RESERVED.

CA #6752
 WWW.MEAENGINEERS.COM

MEAE
 ENGINEERS, INC.
 2352 Appalooosa Circle
 Sarasota, Florida 34240
 (941) 822-3854 CA-6072

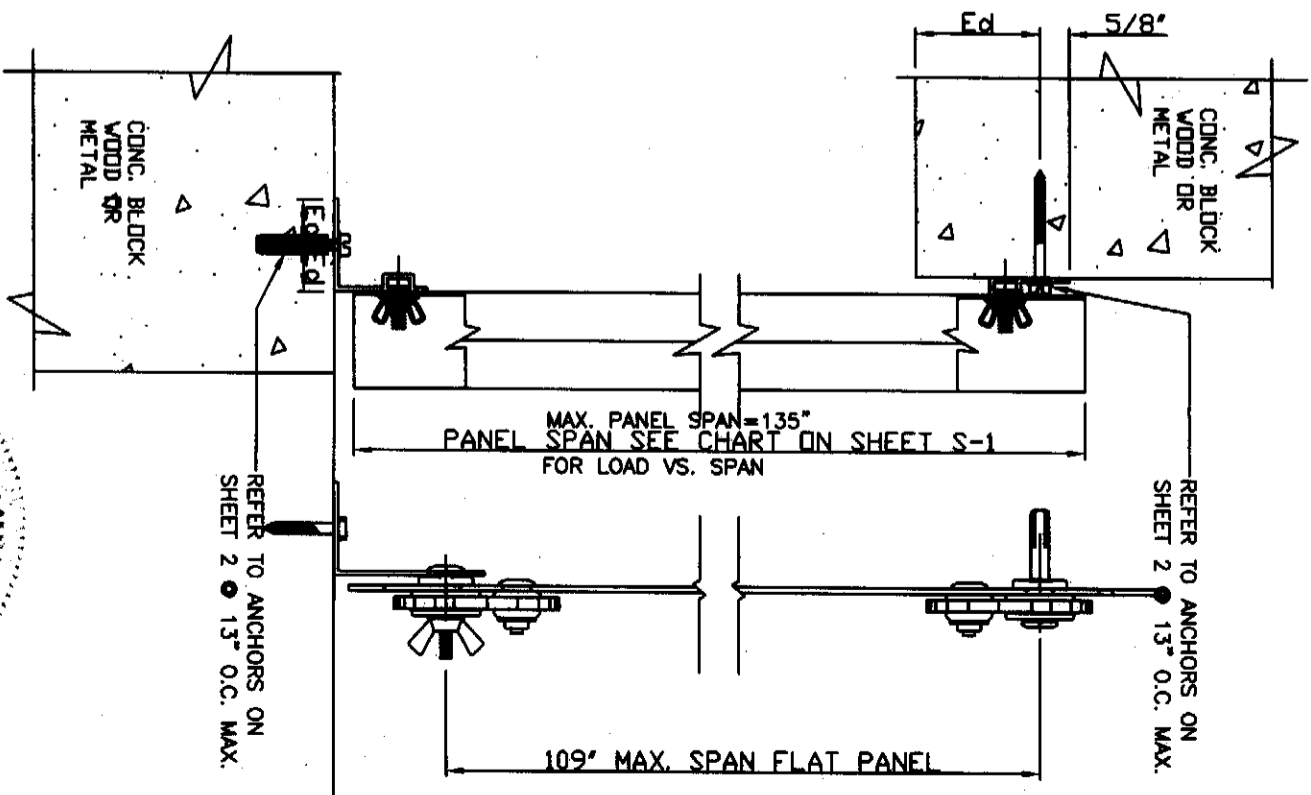
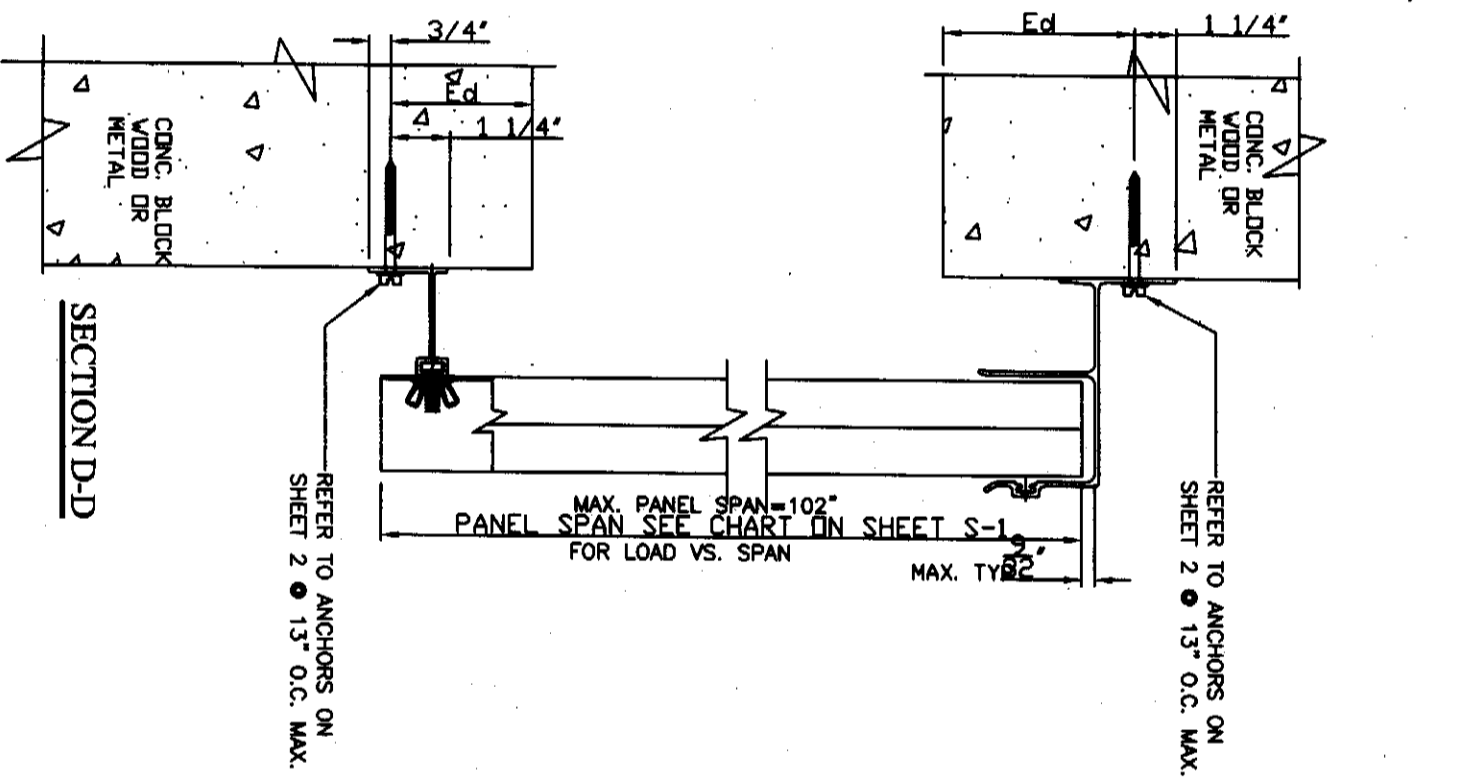
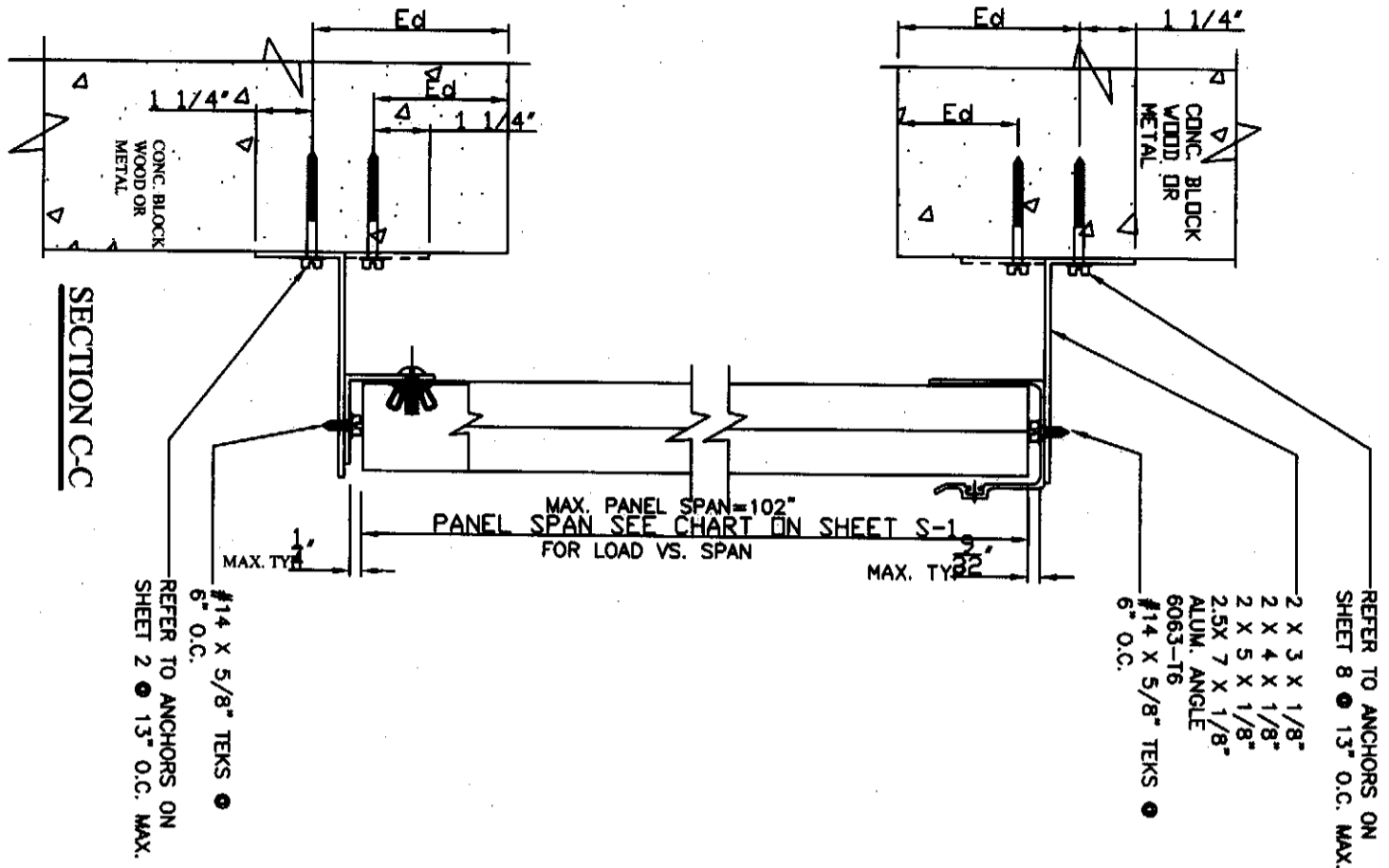

JOHN K. ANDERSON
 LICENSE NO. 47516
 STATE OF FLORIDA
 PE
 DATE: 7/15/15

7/10
 NOTED
 4/30/15

CLEARTEK
STORM PANEL SYSTEM
(HVHZ)

Project Name:
Ultratek Worldwide Inc.
 3801 N. Washington Blvd.
 Sarasota, FL 34234
 PHONE: (941) 924-2285
 www.ultratekworldwide.com

REV.	DESCRIPTION
1	XX/XX/XX - RESERVED.

CA #6752
 WWW.MEAENGINEERS.COM

 2352 Appaloosa Circle
 Sarasota, Florida 34240
 (941) 922-3854 CA-6072

